

magic

www.magicwindow.ca

Better Smarter Windows

Better. Smarter. Windows.

Since 1979, Magic has been on the constant pursuit of innovation.

We don't imitate, we create. Since 1979, we've been designing, patenting, and manufacturing some of the most innovative window and door technologies in Ontario. We're different, not out of dissatisfaction, but out of a desire to lead. Homeowners deserve the best, more light, cleaner air, and better energy performance and we believe they're willing to invest in it.

Our innovations stem from years of research, prototyping, and testing, ensuring top-tier performance. We do this because great brands endure and shape culture. With tens of thousands of installations across Ontario, we're recognized for delivering best-in-class products and experiences and we're just getting started.





50% More Light

Hide your bugscreen away when you don't need it.

Traditional bug screens block 50% of your natural light, view, and collect dust, dirt and allergens. But the truth is, you only need a screen when your windows are open.

That's why our operable windows feature **patented retractable screen technology** invisible when not in use, instantly ready when needed.

More light. Clearer views. Cleaner home. Better energy efficiency.

Need service? The screen cassette is easily removable, just pop it out for quick replacement. Simple, smart, seamless.





Cranks Don't Work

They strip, break, loosen and fail over time.

Crank windows are flawed, they're hard to use and keep people from opening their windows. That's why we invented **Parallex® Hardware**: an award-winning system that eliminates cranks for smoother operation, superior durability, and better performance.

Parallex® delivers tighter seals for improved energy efficiency, wider openings for clearer views and airflow, and a safer emergency exit. It comes standard on nearly all our push-out windows.







Clean The Outside, From The Inside

The easiest window to clean. Ever.

Never again will anyone have to risk climbing up ladders to clean your second storey windows. All of our operating push out window styles have the ability to rotate and tilt outwards to 90 degrees so that the outside glass can be washed from the inside of your home. Now you can achieve a cleaner, brighter home with clearer views and more natural light.

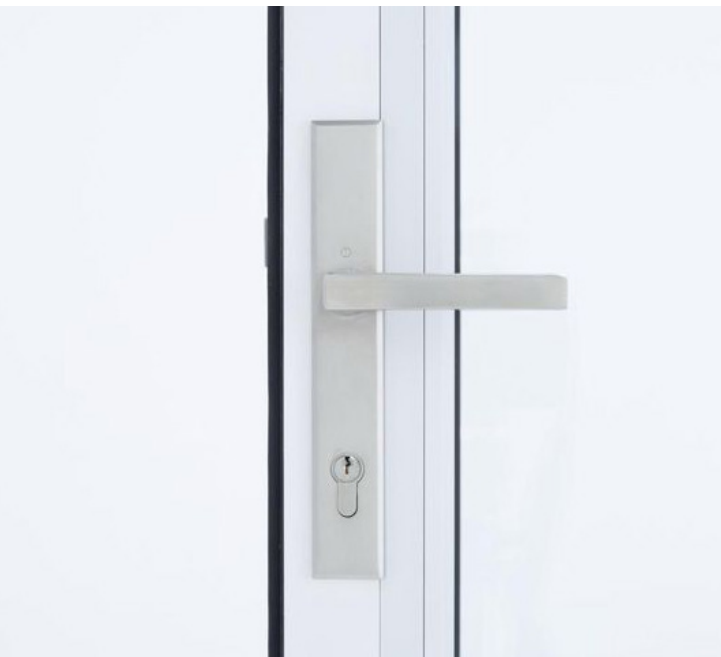

Sleep Easy At Night

With the highest possible security rating.

We design our windows and doors for real-life protection and peace of mind. Our stainless steel cam and multi-point locks exceed top industry security standards. Both systems earned the highest AAMA rating for home entry safety. **Parallex® Hardware** ensures fast, easy emergency exits for all users. At the same time, our **Parallex® Hardware** system makes it incredibly quick and simple for seniors and those with disabilities to open and escape from their windows in case of emergency.

Grade 40 Security Rating





Hybrid Fusion Frame

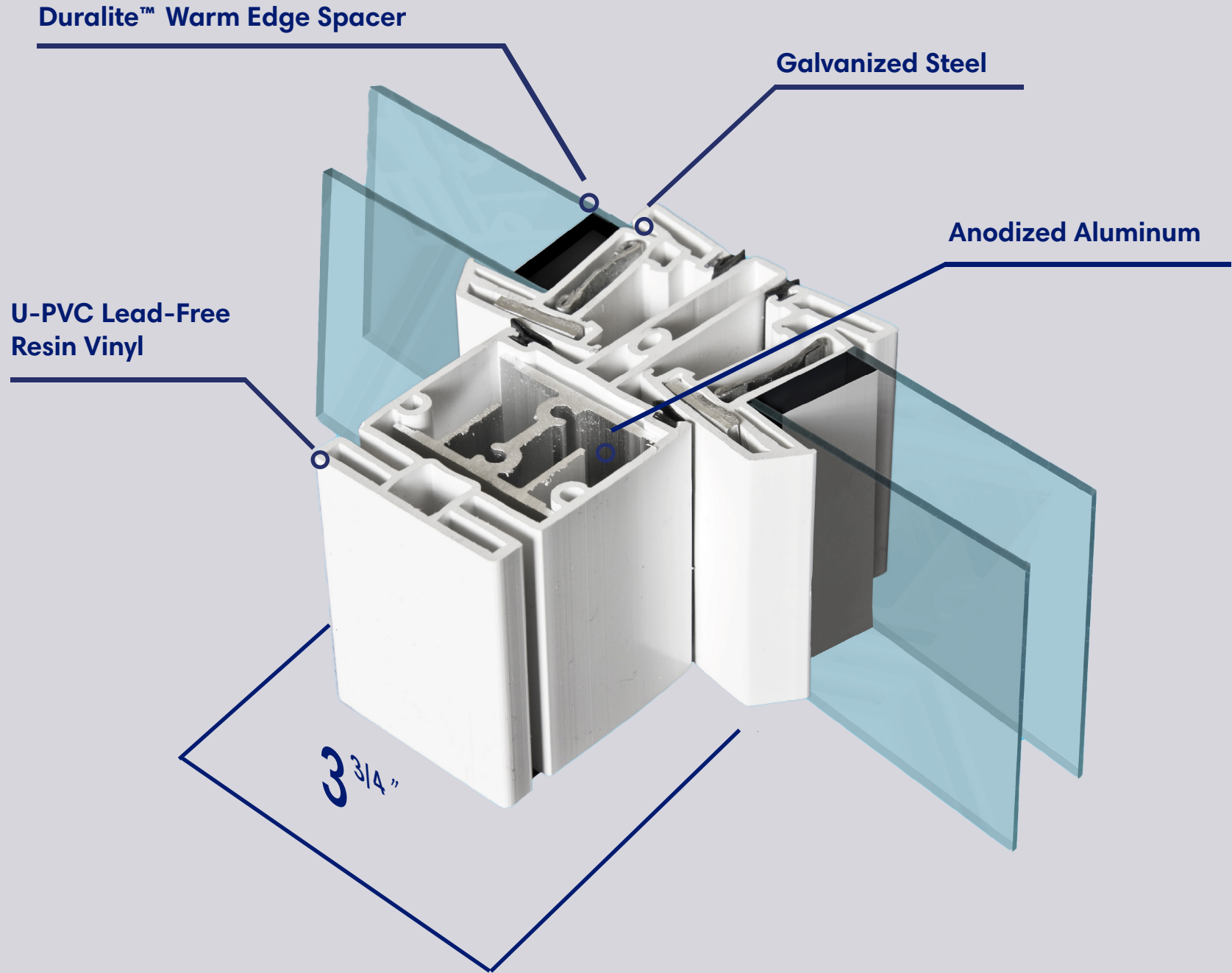

The Frame

A slim, strong solution that doesn't flinch when it comes to efficiency.

Our **Hybrid Fusion Frame** combines lead-free UPVC with steel and aluminum. You get the energy efficiency and low maintenance of vinyl, plus added strength. Our frames easily withstand the punishment of extreme weather (after all, we do live in Canada). They wipe clean, and don't fade, chip, rot, dent, or corrode like other building materials.

Details. Details. Details.

Our patented **Hi Flo**[®] polycarbonate drain won't swell or crack, eliminating water buildup. As an added bonus, the weeper blocks air drafts and insect penetration.



Hi-Flo Drainage System



Our Window

Our Competition

Less Frame, More Glass

Make your neighbours jealous.

Gone are the days of big, bulky replacement frames that reduce natural light and make your home look like a military base. Our Ultra Slim Profile was designed to reduce the frame's size and maximize the glass surface to create a more modern and contemporary look. Even multi-panel windows keep a slim look with mullions reduced by over 50%.

$3\frac{3}{4}$



Our Window

$6\frac{3}{4}$



Our Competition

Energy Efficiency Matters



Energy Star

Bring it on, Winter.

True energy efficiency comes from more than just coatings or seals. Our products are tailored for Southern Ontario using custom glass, tight seals, and smart shade solutions. We're an Energy Star Partner and NFRC certified for trusted third-party performance validation.

Range of Achievable Results			
Window Type	U Factor	Solar Heat Gain	Visual Transmittance
Casement	0.26 - 0.30	0.16 - 0.45	0.30 - 0.49
With Blind/Shade	0.17 - 0.30	0.12 - 0.45	0.00 - 0.49
Vertical Slider	0.25 - 0.31	0.17 - 0.54	0.33 - 0.59
With Blind/Shade	0.20 - 0.31	0.15 - 0.54	0.00 - 0.59
Horizontal Slider	0.26 - 0.32	0.17 - 0.54	0.33 - 0.59
With Blind/Shade	0.21 - 0.32	0.13 - 0.54	0.00 - 0.59
Fixed Picture Window	0.25 - 0.31	0.19 - 0.56	0.37 - 0.61
With Blind/Shade	0.20 - 0.31	0.17 - 0.56	0.00 - 0.61
Patio Door	0.18 - 0.34	0.15 - 0.51	0.33 - 0.56
With Blind/Shade	Pending Laboratory Test Results		
Tri-max Casement	0.17 - 0.21	0.14 - 0.36	0.25 - 0.41
With Blind/Shade	Pending Laboratory Test Results		
Trimax Fixed	0.13 - 0.28	0.18 - 0.56	0.35 - 0.61
With Blind/Shade	Pending Laboratory Test Results		

Range of results based on customizable options.
 Double pane units with energy linds have the same insulating value as our triple glazed units.
 VT of 0, a result of the thermal blind fully eliminating light penetration.
 For more information visit [NFRC.ORG](https://www.nfrc.org) and search "CTW/Magic"



Blueboard o

100% Room Darkening
Retractable Thermal Blind

Protection Against Seal Failure
High Performance Warm Edge Spacer

Higher Security Rating
CAM and Multi Point Lock

Easy to Service
Removable Screen/Blind Cartridge

Slim Frame Profile
Steel Reinforced Lead Free Vinyl

Privacy & UV Protection
Retractable Solar Screen

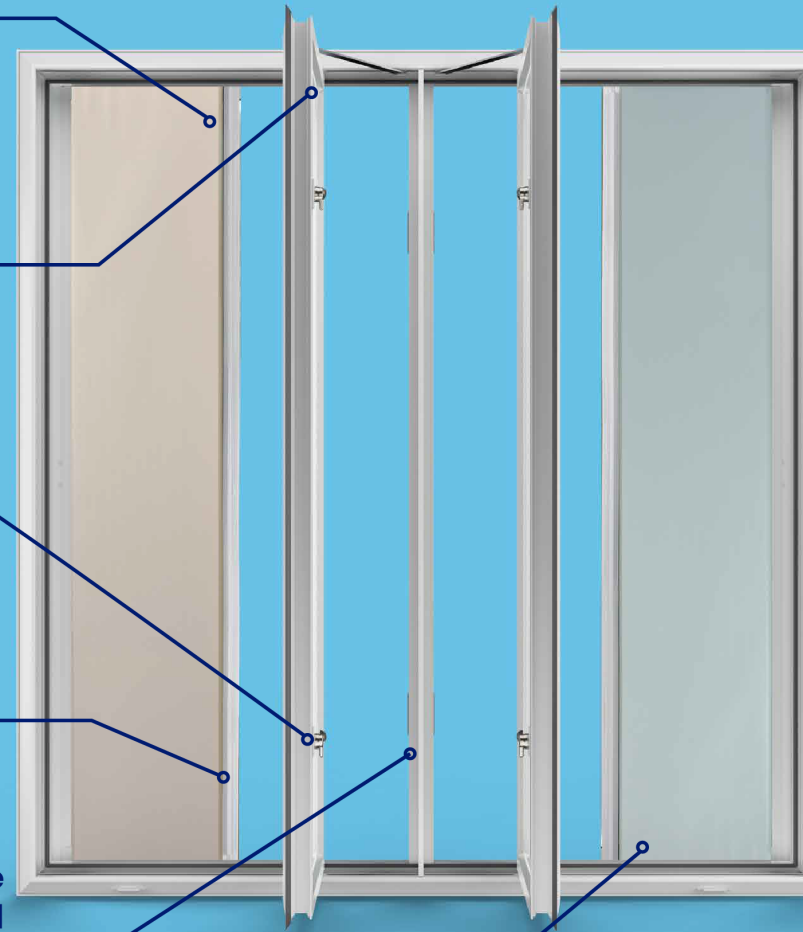
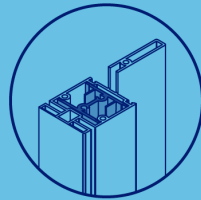
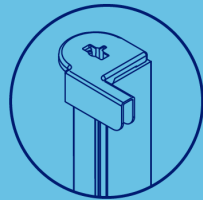
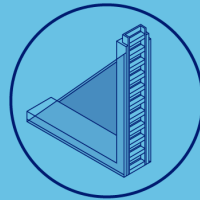

f Innovation

50% More Natural Light
Retractable Insect Screen

Effortless Operation
Parallex® Steel Pivot Shaft

Maximum Ventilation
90° Opening For Easy Cleaning

Crankless Hardware
Parallex® Carrier Shoe & Track

Insect Prevention
Hi-Flo® Drain

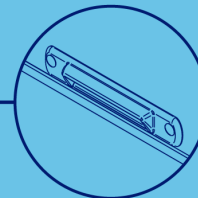
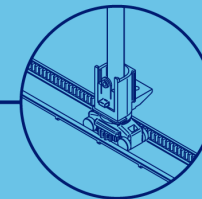
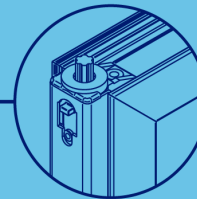

magic Solar Shade

The Solar Shade, which retracts into the window's frame, allows you to control how much heat and natural light enters your home. In warmer, sunnier conditions, the application of the Solar Screen keeps the sun's rays from heating your home, lowering your cooling bills. In colder but sunnier weather, retracting the screen allows you to capitalize on the sun's heat and use it to lower your heating bills. The screen also eliminates glare and keeps U.V. ray penetration from fading your home's furniture and interior décor.

Add On Feature

**Certified Blinds
By NFRC**





magic Thermal Blind

The Thermal Blind offers blackout, privacy, and a sleek alternative to curtains. It boosts insulation at night, cutting heat loss and reducing winter heating bills. By retracting during the day, it lets sunlight warm your home naturally. The Thermal Blind gives you triple glazing performance only when needed, without sacrificing light or comfort.

Add On Feature

**Certified Blinds
By NFRC**









magic Patio Door

Our sliding patio door combines stainless steel, glass, and **Hybrid Fusion Frame** tech for unmatched performance. Patented hardware with brass wheels and a raised steel track keeps it gliding smoothly even with debris. It features a retractable screen, expansive sizes, and sleek design to maximize light and views. Packed with all of Magic's security and performance tech no hockey stick needed for safety.





magic Window Wall

The Window Wall is revolutionary. The system features glass panels that operate independently of one another, letting you open it up as much as you like. It can be made as an entry door size to full wall size and includes a fully adjustable retractable screen.

Panels interlock to form an airtight seal and its Grade 40 security rating is the highest in its class.

Maximum panel size and maximum size depend on a combination of height, width, direction of swing, type of glazing ect. Please consult a rep with your size requirements.





Bring The Outside, Inside

Sometimes boundaries are meant to be broken.

The Window Wall is the first product of its kind that is specifically designed for Canada's extreme climate. It's free of any hinges or other mechanisms that could malfunction due to extreme temperature.

Like all our products, It's fully customizable panel sizes, grills, colours and includes all our patented tech: **Hi Flo**® Drainage, **Hybrid Fusion Frame**, and optional Energy Blind integration.

magic French Door

The Window Wall French Door modernizes tradition with ultra-slim Hybrid Fusion Frames for more glass and less bulk.

Parallex® Hardware creates airtight seals without hinges, enabling floor to ceiling glass.

The Window Wall French Door can be configured to open as a classic dual-swing or a bi-fold, stacking panels to one side.

Common Configurations

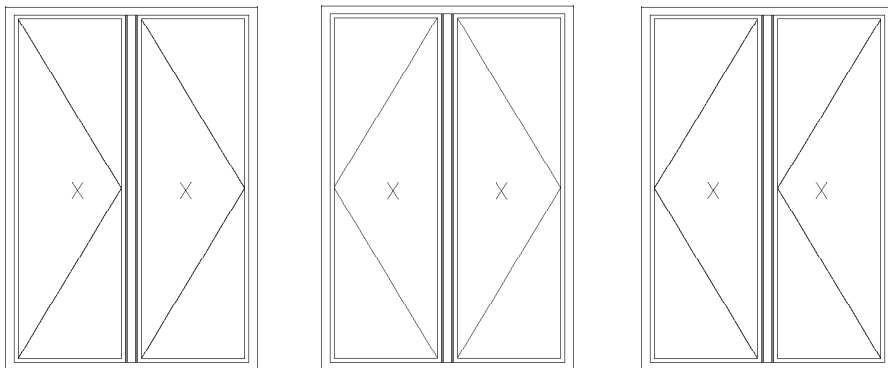



Design Your Windows

An endless array of colours to suit your home's style and preferences.

Magic windows are fully customizable and can feature colour on one side or be painted on both the exterior and interior. We can match nearly any paint colour, making the colour options virtually endless. Below are some of the most common colour options.

We also offer solar shades and thermal blinds in a wide range of colours to boost efficiency and style.

Frame Colour



Handles

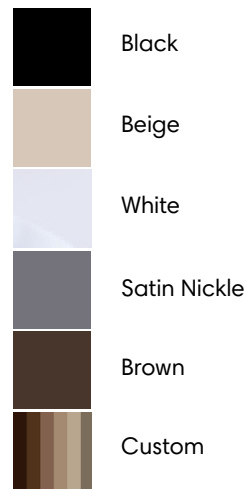

Solar Shades



Thermal Blinds







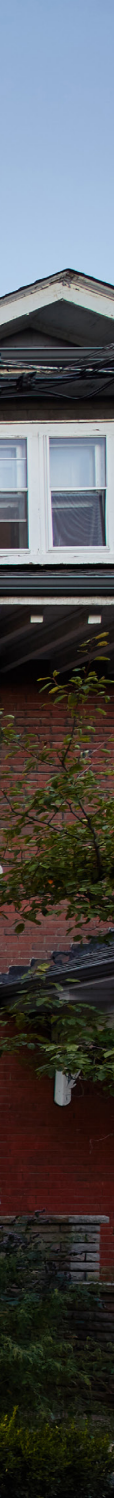

Window Styles and Grills

Add an additional layer of curb appeal to any home.

We offer a wide range of window styles and shapes, all featuring our patented tech. Options include single hung, single, double, and triple sliding configurations.

Choose between 'between the glass' grills or exterior applied simulated lites for a classic look. All designs are fully customizable.

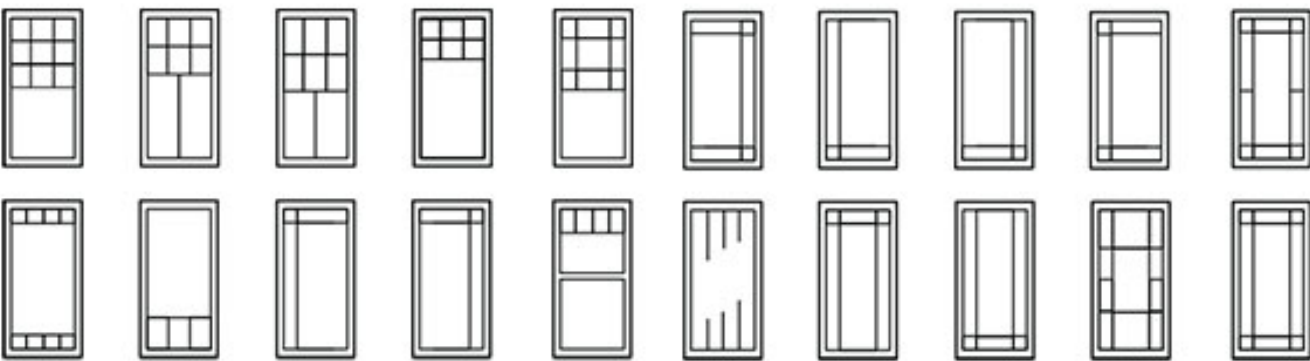

magic Window

Single Casement



Double Casement



Triple Casement

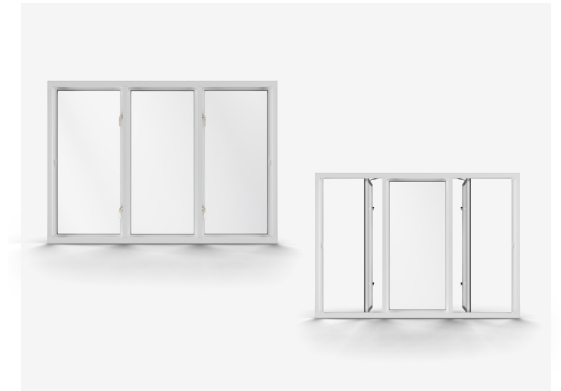

Awning



Awning Over Fixed



Shaped

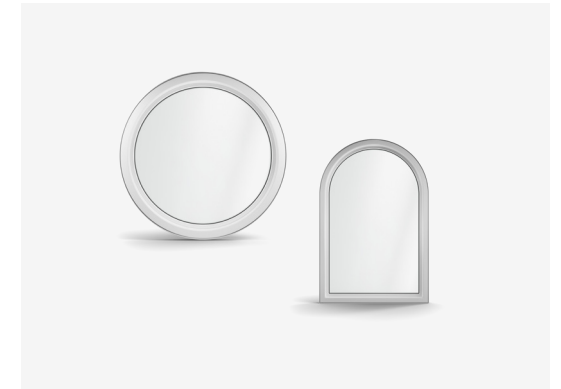

2 Panel Window Wall Window

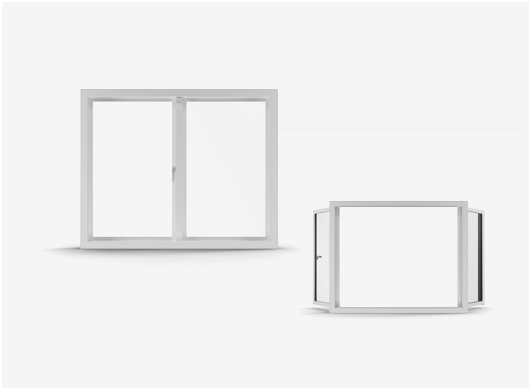

3 Panel Window Wall Window

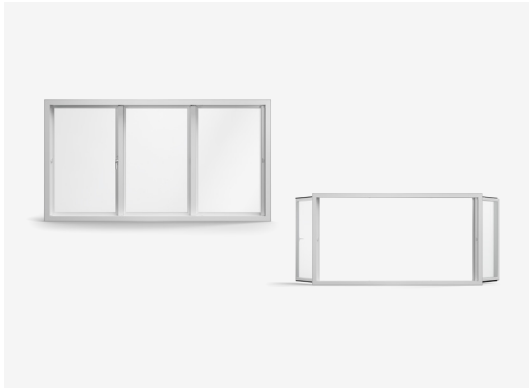

Hung

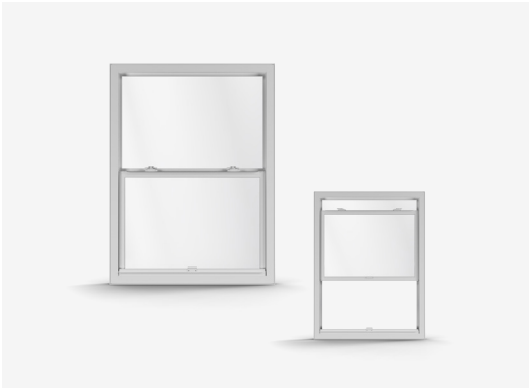

Bay



Bow

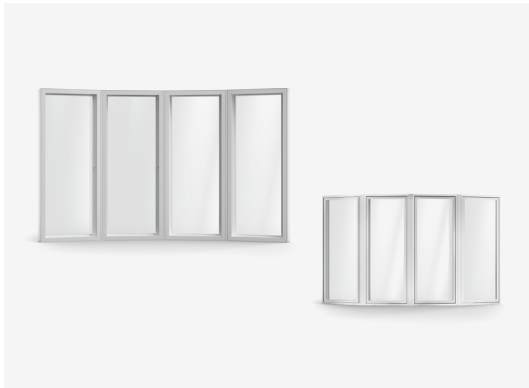

Sliding

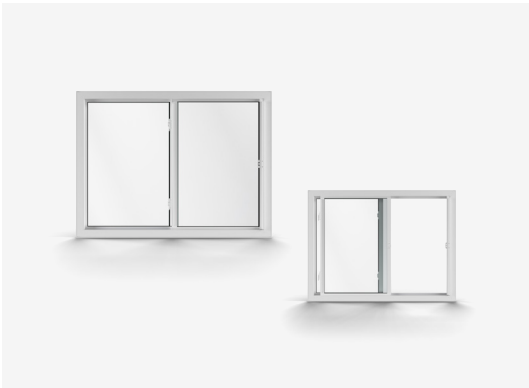

magic Window Wall

Window Wall Entry Door



French Door



2 Panel Window Wall Window

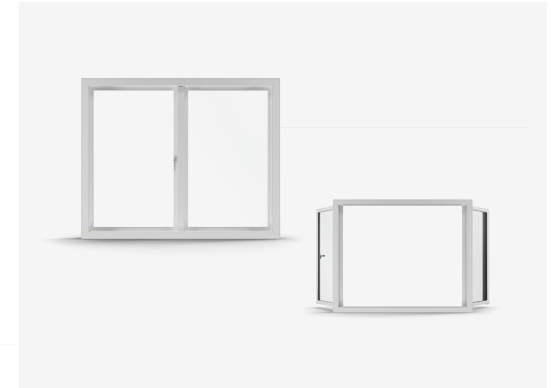

3 Panel Window Wall Window

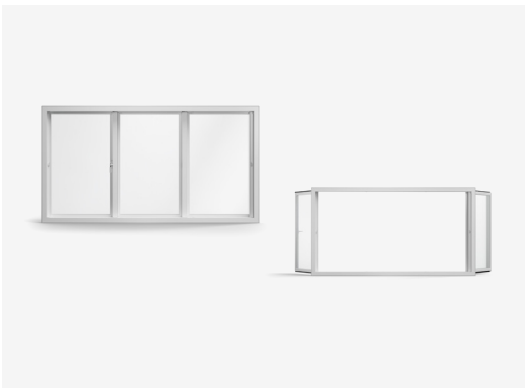

3 Panel Window Wall

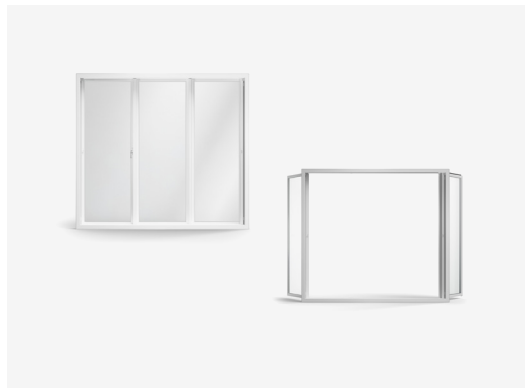

4 Panel Window Wall



magic Patio Door

2 Panel Sliding Door



3 Panel Sliding Door

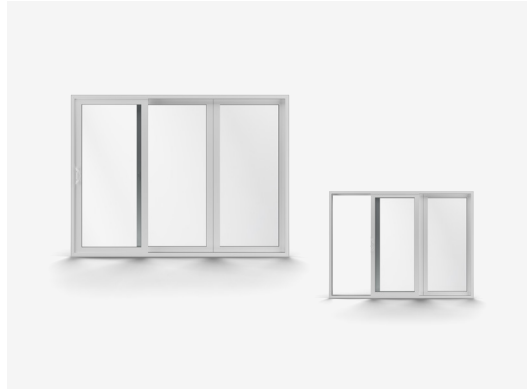

4 Panel Sliding Door

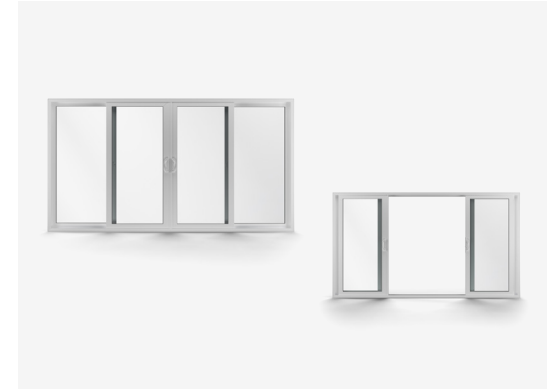





Installation

No outsourcing here.

The best windows in the world are worthless if they're not installed properly. Our installers are trained, certified, and equipped to handle any and every job. We install all year round. Summer or winter, cold or hot, mild or humid, and our installers take every necessary precaution to ensure that we leave your home as clean as when we got there. We also monitor our production so that we can give you a realistic time for completion and so that you can plan accordingly.

40 Year Warranty

Peace of Mind For 40 Years

Yes it's transferable to the
next home owner.

At Magic, there's no such thing as a bad customer experience. Product innovation and customer care lie at the heart of our business, which is why every component of our product is covered by our industry leading 40 year warranty. From frame, glass, screen, and blinds we've got you covered on all parts and labour.



magicwindow.ca

75 Rowntree Dairy Rd.
Woodbridge, ON L4L 6C8
You should call us right now! 1-866-OK-MAGIC